

**PROGRAMMING AID**  
**HILFSSKIZZE FÜR DIE PROGRAMMIERUNG**  
**ESQUEMA DE AYUDA A LA PROGRAMACION**

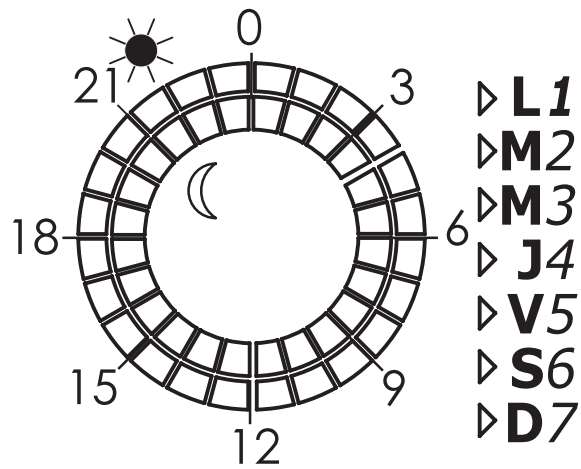
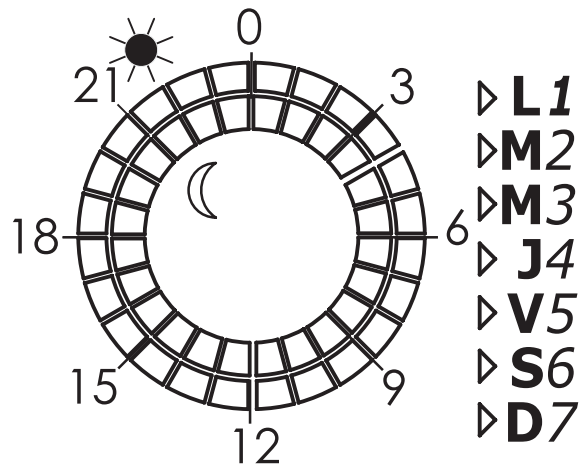
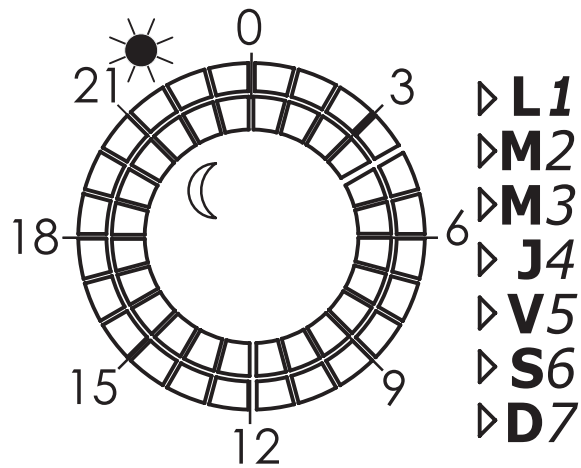

The appliance you have just purchased has undergone many checks and test to ensure its quality. We thank you for your confidence in our product and hope that you will be completely satisfied with your choice.

**Some advice:**

Please read these instructions before starting to install the programmer.

Keep these instructions in a safe place, even after you have installed the unit.

Before operating it, remove the protective film from the screen.

**DESCRIPTION**

A diagram is provided opposite to assist you in programming.

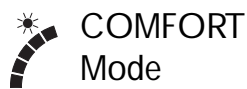

**Programming example**

It is 20.30 on Saturday.

Setting for the day and the time

Monday, Tuesday, Thursday and Friday: COMFORT mode from 06:00 to 09:00, and from 17:00 to 23:00.

Wednesday: COMFORT mode from 06:00 to 09:00 and from 12:00 to 23:00.

Saturday and Sunday: COMFORT mode from 07:00 to 00:00.

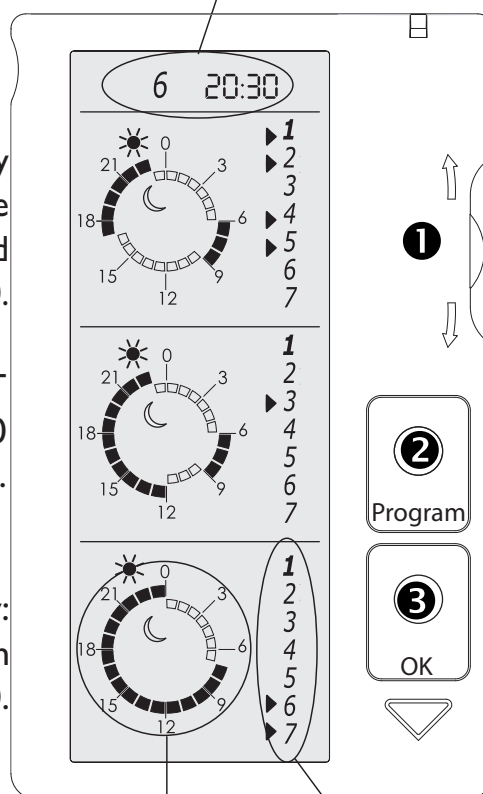

Programme Days

① Navigation bar enabling you to move around in the display by moving the bar up or down.

② Button for modifying the programming, the day and the clock.

③ Confirm button.

## USE

### Activating the programmer

Pressing any button or removing it from its bracket makes the screen appear unless the programmer has been set to Child Safety mode (see the "Child Safety" section).

### Setting the clock

Move the navigation bar **1** downwards to make the clock zone flash.

Pressing button **2** enables you to access Day Setting mode. You can then scroll through the days by moving the navigation bar **1** up or down. Confirm the day by pressing button **3** and proceed in the same way to set the hour and the minutes.

Pressing button **3** confirms the clock setting (the whole clock flashes).

You can then use the navigation bar **1** to move to another zone or hold the screen details by pressing button **3**.

### Programming ECO COMFORT

Move the navigation bar **1** up or down to select the time period to be changed (the whole period flashes).

Pressing button **2** enables you to access the time period selected (the first time setting flashes).

You can move within the time period using the navigation bar **1**. Every time you move, the selected element flashes and the choice of Eco or COMFORT can be changed by pressing button **2**. Pressing button **3** confirms the programme (the whole time period flashes).

You can then use the navigation bar **1** to move to another zone or hold the screen details by pressing button **3**.

### Programming days for the programme.

Move the navigation bar **1** up or down to select the zone for the days to be changed.

Pressing button **2** enables you to access the days to be selected (the first day flashes).

You can move around the days using the navigation bar **1**.

Every time you move, the selected element flashes. The day selected can be modified by pressing button **2** (in the example,  Thursday is selected).

Pressing button **3** confirms the days.

You can then use the navigation bar **1** to move to another zone or hold the screen details by pressing button **3**.



1  
2  
3  
4  
5  
6  
7

### Sleep mode

The programmer's display automatically goes into Sleep mode if the buttons are not used for 4 minutes.

### Child safety

Hold down button ③ and then press button ② to set the programmer to Child Safety mode (the buttons are then disabled). Repeat the procedure to reactivate the programmer.

### Configuring the display

Hold down buttons ② and ③ and briefly press the RESET button on the back of the programmer using a pointed object (a pen). The day flashes. You can then change the display by pressing button ②.

Confirm by pressing button ③.

1  
2  
3  
4  
5  
6  
7

## INSTALLATION USING A PILOT WIRE INTERFACE

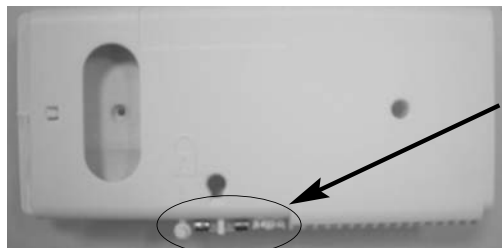

FIG. 1  
Locking pin  
Fuse  
Screw

### Some precautions and advice on use.

Before installing the interface, check that the programmer's pilot wire (black conductor) is connected to a spare connection block or to a pilot circuit only containing electronic control units (Drawings 1 & 2).

Under no circumstances may the pilot wire for a unit fitted with an interface be:

- ♦ Connected to a Live conductor (Drawing 3).
- ♦ Connected to another timer (Drawing 3).
- ♦ Connected to a Neutral conductor (Drawing 4).

An appliance fitted with a programmer can handle a maximum of 15 electronic control units.

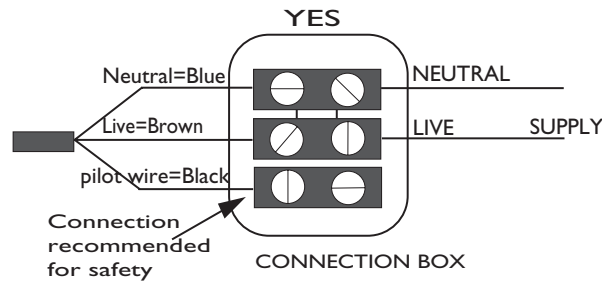

Drawing 1

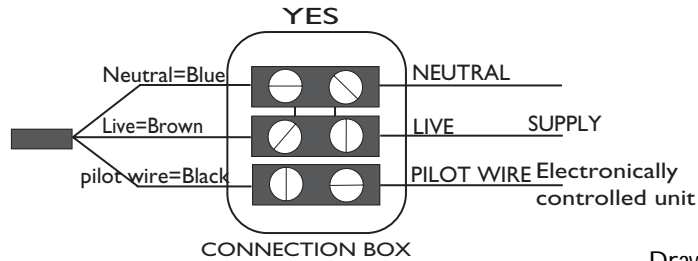

Drawing 2

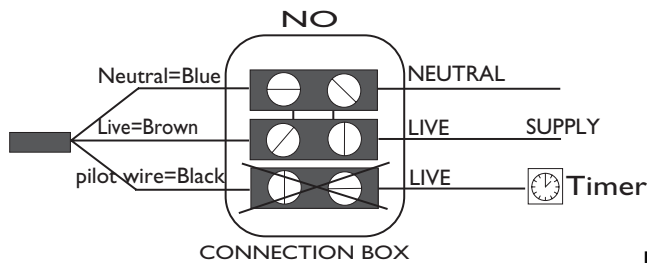

Drawing 3

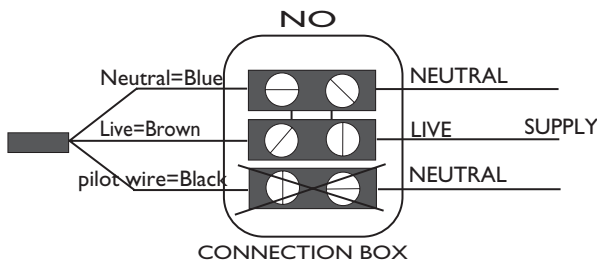

Drawing 4

## ON WHICH TYPE OF UNITS SHOULD THE INTERFACE BE INSTALLED?

### 1- Installation with or without a pilot wire?

The number of interfaces and their addition to units not so equipped depends on whether there is a pilot wire in your electrical system.

A pilot wire is an electric cable that transmits orders from the programmer (Comfort or Eco temperature level) to the connected appliances at the desired date and time.



**Before doing any programming work on your appliance, switch the installation OFF.**

### a-Your dwelling has a pilot wire

The appliance fitted with your interface and the programmer will “control” all the units connected to it.

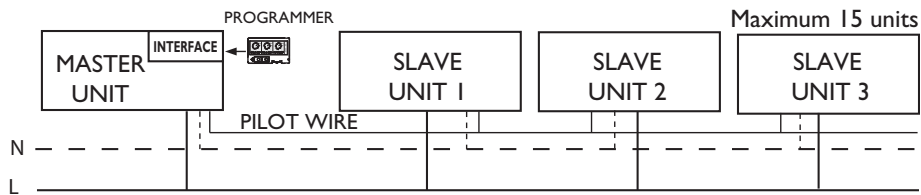

Since rooms are occupied in different ways day and night, you should create a day zone (for example, the master unit will be in the Lounge and control the slave units in the Dining room, the Kitchen and the entrance hall) and a night zone (for example, the master unit will be in the master bedroom and will control the slave units in the children's bedroom).

All the units linked to the “Master” unit will therefore receive the same programming instructions and therefore constitute a single programming zone.

#### **WARNING:**

Two interfaces must not be installed in the same programming zone.

You must comply with the polarities for connecting the Live and the Neutral on all the units in a zone (Blue=Neutral,Brown=Live).

### b-Your dwelling does not have a pilot wire

You can programme unit by unit by fitting each unit in each of the rooms concerned with an interface and a programmer: each unit is then autonomous.

#### **WARNING:**

Even if your dwelling does not have a pilot wire, your appliance has one. In this type of installation, you must connect the pilot wire to a spare connection block.

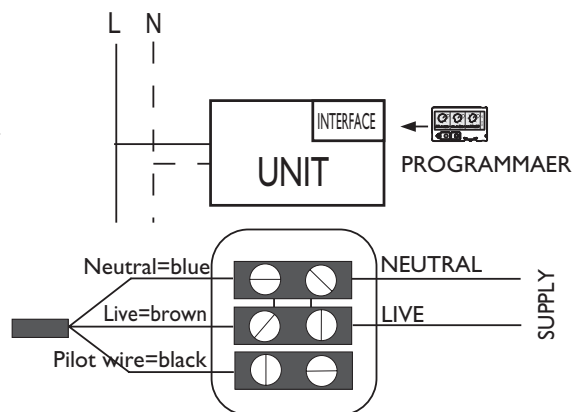

Connection recommended for safety

**c- How to install the interface on your appliance?**

- 1) Remove the appliance from the wall (after switching off the power supply).
- 2) Remove the transparent protective cover with a screwdriver.

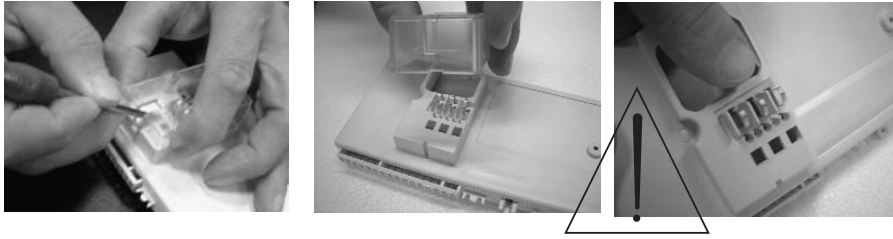

Do not bend the contact lugs.

- 3) Place the interface in the housing for it in the appliance's casing.

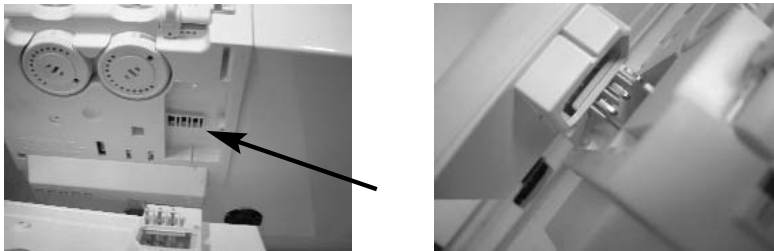

- 4) Fasten the interface in place using the 2 screws provided (do not use any other type of screw). Screw it in tightly.

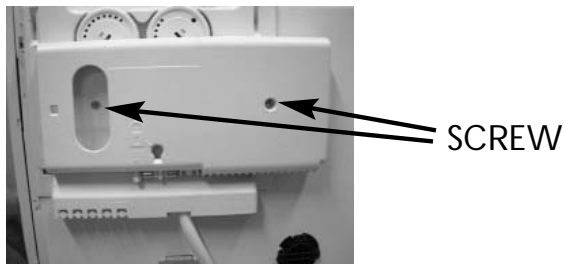

- 5) Refit the appliance on its brackets and switch it ON.
- 6) Insert the programmer in the interface.

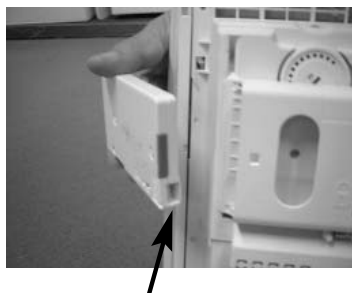

Connector facing downwards

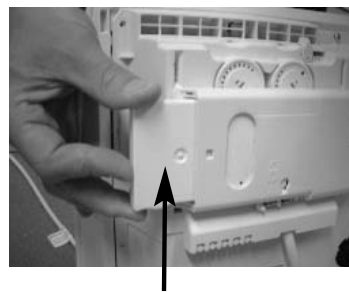

Rear side facing the wall

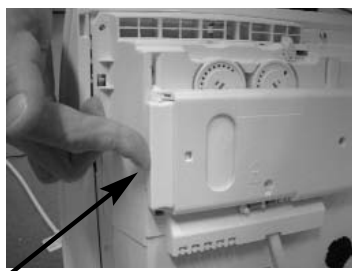

Press it in fully

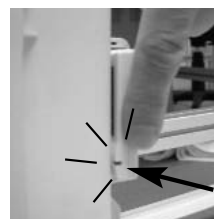

The indicator light should flash five times in succession (to confirm that the programmer is correctly connected).

## 2- Safety fuse

The pilot wire interface is fitted with a fuse to protect against inappropriate installation or serious fluctuation in the electrical supply. If the fuse blows, the programmer sends no programming instructions and the connected units operate in "Comfort" mode. After correcting the installation, proceed as follows to replace the fuse:

- a- Remove the fuse holder and its fuse (manually)



- b- Replace the fuse (100mA) with the replacement fuse.



- c- Refit the fuse holder and fuse in its housing.

## 3- Anti-theft function

To avoid removal, the interface is fitted with a pin (**FIG 1**) to lock the programmer in its operating position.



## INSTALLATION WITH A CARRIER CURRENT INTERFACE

Please refer to the specific instructions supplied with the carrier current interface.

## INSTALLATION ON TOWEL DRYERS

For programmable towel dryers, the programmer is fitted in the rear of the control box.



## MAINTENANCE

The battery must be changed when the battery symbol is displayed (CR 2032 button-type battery).

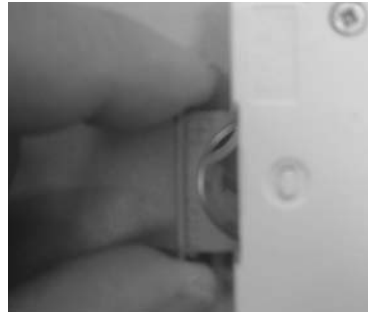
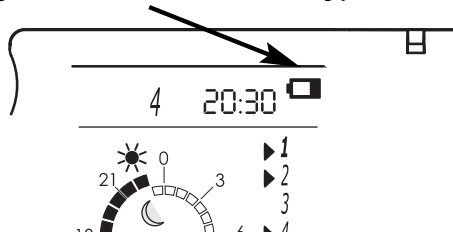

## WARNING



Ensure that no foreign bodies fall into the interface when it is without a programmer.

## WARRANTY CONDITIONS

### **KEEP THIS DOCUMENT IN A SAFE PLACE**

*(To be presented by the user only in the event of a claim)*

The guarantee period is two years from the date of installation or purchase and may not exceed 30 months from the date of manufacture in the absence of a receipt.

The guarantee covers the replacement and supply of components recognised as being defective, excluding any damages or interest.

The user is responsible for any labour or transport costs.

The guarantee does not cover any damage arising from improper installation, abnormal use or non-observance of the requirements of the said instructions for installation and use .

The stipulations of the present guarantee conditions do not exclude any of the purchaser's legal rights of guarantee against faults or hidden defects, which are applicable in all cases under the stipulations of Articles 1641 of the Civil Code.

Present this certificate to your distributor or installer only in the event of a claim, together with your purchase invoice.

INSTALLER'S STAMP



ATOIR ATLANTIC LTD  
Malling Works, Lewes  
East Sussex BN7 2AY  
Phone 01 580 2431 53  
Fax: 01 580 2411 80  
E-mail: sales@tour-atlantic.ltd.uk